

# Polishing material removal correlation on PMMA – FEM simulation

**R. Almeida**

[ruil.almeida@hs-aalen.de](mailto:ruil.almeida@hs-aalen.de)

Aalen University of Applied Sciences, Centre for Optical Technologies, Aalen, 73430, Germany

**R. Börret**

Aalen University of Applied Sciences, Centre for Optical Technologies, Aalen, 73430, Germany

**W. Rimkus**

Aalen University of Applied Sciences, Centre for Calculation and Simulation, Aalen, 73430, Germany

**D. K. Harrison**

Glasgow Caledonian University, School of Engineering and Built Environment, Glasgow, G4 0BA, United Kingdom

**A. K. M. DeSilva**

Glasgow Caledonian University, School of Engineering and Built Environment, Glasgow, G4 0BA, United Kingdom

The complexity of polishing is very high and experience in this field is required to achieve reproducible deterministic results concerning shape accuracy. The goal of this work is to predict the material removal of the polishing process on PMMA (Polymethylmethacrylate) using an industrial robot polisher. In order to predict the material removal, a FEM Model was created representing the polishing process. This model will help to predict the material removal when polishing parameters are changed. Experiments were carried out and compared to the results obtained from the different parameters tested in the simulation.

[DOI: <http://dx.doi.org/10.2971/jeos.2016.16012>]

**Keywords:** Polishing, simulation, FEM, material removal

## 1 INTRODUCTION

Polishing is a manufacturing process that exists for a long time [1] and is known to be used for finishing of optical components. This process is used for the removal of feed marks, which are caused by previous manufacturing processes like grinding, or when an improvement of the surface roughness is needed. The polishing process itself is characterized by cutting with loose/bond abrasives [2] with the purpose to generate minimal surface roughness at small rates [3]. The principle for the material removal mechanism is that the abrasives are mixed in the polishing fluid guaranteeing that they are suspended in the fluid giving the possibility to roll freely between workpiece and tool (lapping) or to penetrate into the tool losing the freedom to roll (polishing).

The goal of this research is to be able to predict the material removal that will occur during polishing in order to achieve good results concerning shape deviation in steel moulds. A simulation model shall be developed and further used for the material removal prediction. For its validation it shall be compared with real experiments. This goal shall be achieved not only in flat surfaces but also in curved and freeform surfaces.

There are different parameters in this process that influence the surface roughness and the material removal rates. Simulating the process will help to predict the resulting material

removal, when one of the parameters is varied. This will enable the correction of geometric forms avoiding the need for iterative trial and error polishing.

## 2 AIMS OF THE RESEARCH

The complexity of the polishing process is very high. Due to the many different parameters that exist in the process, a lot of experience is required in this field. The goal to understand the material removal that takes place during the polishing process of flat plastic samples, also known as PMMA. This material was chosen because it allows quick tests due to the high removal rates compared to other optical materials. For this purpose a Finite Element Method Model was developed, allowing the prediction of the different polishing parameters and avoiding the iterative trial and error polishing. This will help to determinate the material removal, which is caused by a set of parameters, before actually starting the process and find a set which fulfils all requirements. Compared to previous work [4] simulation allows the description of the local removal mechanism and the improvement of the process. Despite some small deviations it was possible to achieve a good correlation between FE simulation and results of the experiments using the explicit finite element program LS-Dyna [5]. This makes the combination of the simulation with the finite element method a strong tool in order to achieve better results.

### 3 MATERIAL AND METHODS

#### 3.1 Experimental setup

Several experiments were carried out using the ABB IRB 4400 industrial robot, which is a large robot and has a low accuracy compared to other robots in the market. PMMA together with a standard slurry for plastic polishing is used as the starting parameter set. All samples (size  $10 \times 50 \times 50$  mm) were polished using a polishing tool with a 16 mm diameter polishing pad and foam. A single path was polished 42 times with a cerium oxide slurry, grain size of  $1 \mu\text{m}$ . The samples were fixed to a holder with an adhesive tape, as is shown in Figure 1. The purpose behind this, is to allow the sample to always be measured and polished in the same position avoiding the error that would come by repositioning the workpiece. An additional adapter, made of POM (Polyoxymethylene), was also produced in order to maintain the polishing slurry on top of the surface.

The parameter which was studied in the first experiments was the pressure because it is the parameter that has the biggest influence on the material removal as stated by the Preston Equation [6]. According to the Preston Equation the material removal is increasing proportionally with the pressure. Which is why all the polishing parameters were left constant and the pressure was varied. The parameter that was studied in the second experiments was the rotation speed of the polishing tool. An overview of the experimental procedure is listed below in the Table 1.

On the work pieces a single line was polished continuously. As the Figure 1 shows the polishing tool moved through the line forward and then backwards. This was done in order to know the material removal that happens while polishing a single line. Because when a surface is polished, the same line is

polished different times with a small overlap all over the surface. Therefore it is important to know the material removal of a single line.

#### 3.2 Measurement devices

During the series of experiments, a Zygo white light interferometer (Ali Schneider 201) with the help of the respective program MetroPro, with CTV5 application, was used to measure and determinate the material removal at different stages of the process. Before polishing and at every six iterations of the line the workpiece was measured in order to obtain the material removal that happened through the process. This measuring machine was used because it allows a measurement to be conducted within minutes, which does not happen when a tactile measurement is done. The CTV5 application provided good support because it enables the measurement before polishing, giving the possibility to see the changes that occurred on the surface during the polishing process.

#### 3.3 Experimental results analysis

With the help of the application CTV5 from the software MetroPro, and the software MATLAB, it was possible to undertake a correct analysis of the experiments. With MetroPro it was possible to output the cross section line of the path as shown in Figure 2. With MATLAB it was possible to use these sectional lines and analyse the depth of the ma-

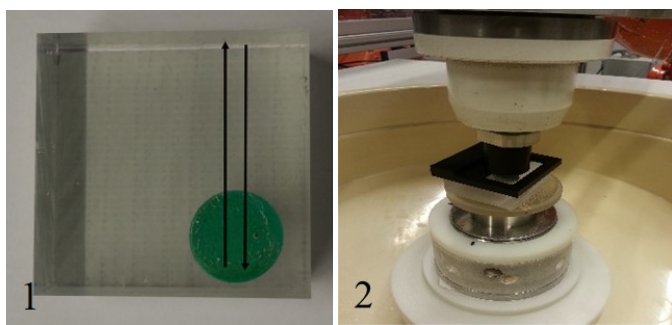

FIG. 1 1- Practical polishing path during the experiments; 2-Polishing robot in action during polishing experiments.

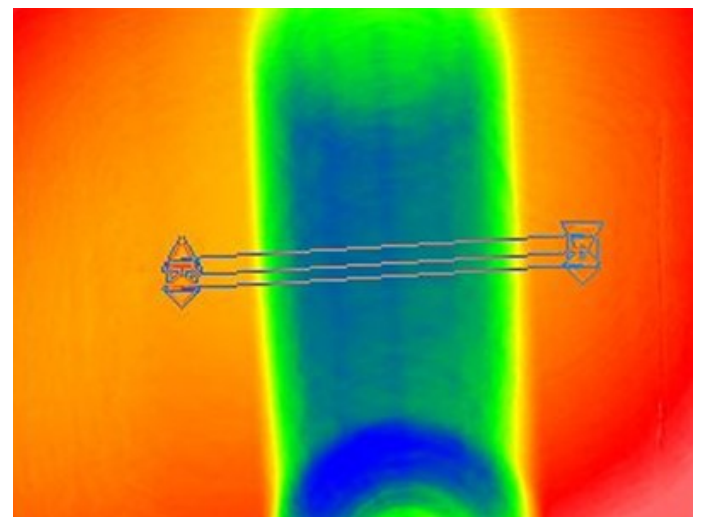

FIG. 2 Cross sectional lines of the polished path used for the evaluation of the material removal during the polishing experiments (field of view  $45 \times 32$  mm).

	Pressure variation	Revolutions variation
Force of the polishing tool	10 N, 20 N, 30 N, 40 N	100 rpm, 200 rpm, 300 rpm, 400 rpm
Rotation speed of the polishing tool		300rpm
Feed of the polishing tool		15mm/s
Polishing tool diameter		16mm
Polished times		42 times
Measurement		Every 6 <sup>th</sup> time

TABLE 1 Overview of the experimental procedure

terial removal (Figure 3). The interferometer measurements were filtered with the piston, tilt and power terms. The removal of material was calculated for each measurement until the workpiece was polished 42 times. With a table calculation tool it was possible to obtain the variation of the material removal with the iterations of the line, evaluate the results from the simulation and to correlate the material removal on PMMA.

### 4 FINITE ELEMENT MODEL

The Finite Element Method program LS-Dyna was used to create a model that represents the characteristics of the polishing process using the industrial robot. LS-Dyna was already used (as stated earlier by [5]) to simulate the polishing process. The model has the material properties of the different components that were used during the experiments. As shown



FIG. 3 MATLAB experiments analysis. Showing in the X-axis every 100 nanometres the material removal depth. Showing in the Y-axis every 10 pixels the distance of the cross sectional line.

in Figure 4, the model consists of seven parts: 1-the drive; 2-the guide, 3-the tool; 4-Workpiece (40 mm × 20 mm × 1 mm) with a fine mesh; 5-Workpiece (40 mm × 20 mm × 2 mm) with a rough mesh; 6-the foam material (ø16 mm, 6 mm thickness) and 7- the Polishing Pad (ø16mm, 2mm thickness). The workpiece is modelled using the elastic-plastic properties of PMMA material. The mechanical properties of the materials can be found in the Table 2.

### 5 RESULTS

#### 5.1 Experiment

The consistency of the material removal during the polishing process is a very important aspect in order to be able to do a correction of geometric forms. There are some factors that could influence this consistency such as: appropriate polishing tool, concentration of the polishing slurry or the accuracy at the industrial robot. It is important to know if the same results are able to be obtained using a set of parameters while executing exactly the same procedure. This will make it easier to understand the different parameters, which can be varied and applied according to the required removal of material. Therefore it will be possible to use simulation results to predict different removal of material. In order to test this consistency of results the same set of parameters and the same procedure was conducted four times.

As shown in Figure 5, it is possible to obtain the same results, when the same set of parameters is being used. All of the represented values belong to experiment 1 and the other experiments results were within a range of 10% error of experiment 1. These small deviations are especially caused by the opti-

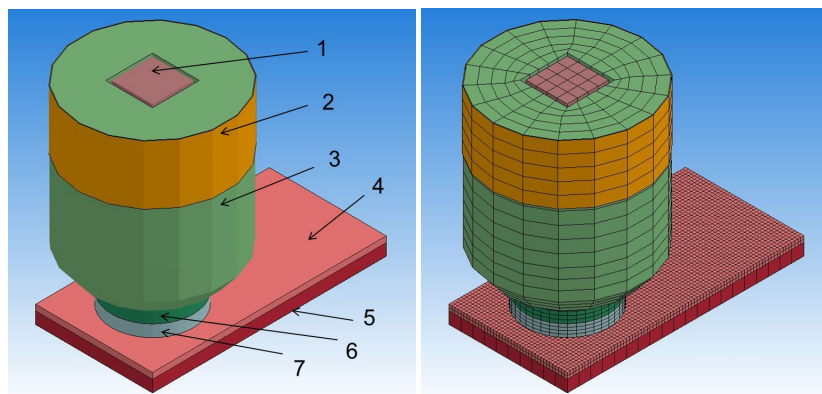

FIG. 4 Left: 3D geometric model composed by seven parts. 1-the drive (Steel), 2-the guide (Steel), 3-the polishing tool (POM), 4-work-piece (PMMA 40 mm × 20 mm × 1 mm) with fine meshing, 5-work-piece (PMMA 40 mm × 20 mm × 2 mm) with rough meshing, 6-foam layer (Sylodyn ND ø 16 mm × 2 mm), 7-polyurethane layer (LP-66 ø 16 mm × 2 mm); Right: The simulation model with a hexahedron meshing type.

Parameter	Drive	Guide	Tool	Foam	Pad	Workpiece
Material	Steel	Steel	POM	Sylomer	Polyurethane	PMMA
Density(ton/mm <sup>3</sup> )	7.85E-9	7.85E-9	1.42E-9	4.0E-10	4.16E-10	1.2E-9
Young Modulus(MPa)	210E3	210E3	3100	-	-	3100
Poisson Ratio	0.3	0.3	0.35	-	-	-
Shear Modulus(MPa)	-	-	-	260	270	-

TABLE 2 Mechanical properties of simulation materials

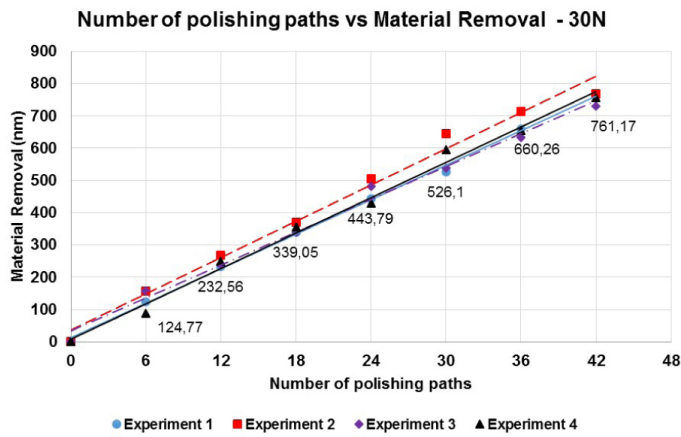

FIG. 5 Different experiments showing a consistency of results using the same set of parameters.

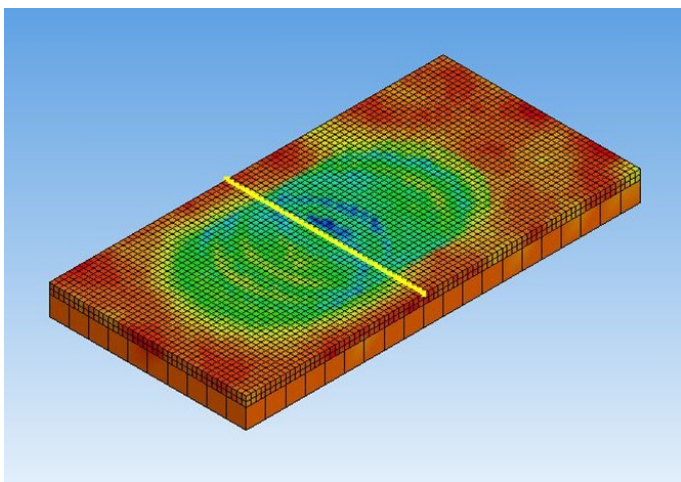

FIG. 6 Simulation results of the deformation in the Z direction, showing measured cross sectional line.

cal measurements because the deviations presented above are in the nanometres range. With these experiments we can conclude that with our procedure it is possible to have a consistency of results.

### 5.2 Simulation

The results from the simulation model were used to obtain a correlation between experiment and simulation. When pressure was changed, it was possible to see that the deformation in the Z direction was increasing proportionally with the pressure. This would prove that the deformation from the workpiece in the simulation follows the Preston Equation [6]. The deformation in the Z direction was measured through a cross sectional yellow line as shown in Figure 6. The deformation on each element was taken into consideration and an average was calculated. With this average deformation a relation was found between the results from simulation and experiment. With this relation it is possible to create a correlation, using the simulation values, to predict the material removal that occurs during the polishing process of flat plastic pieces.

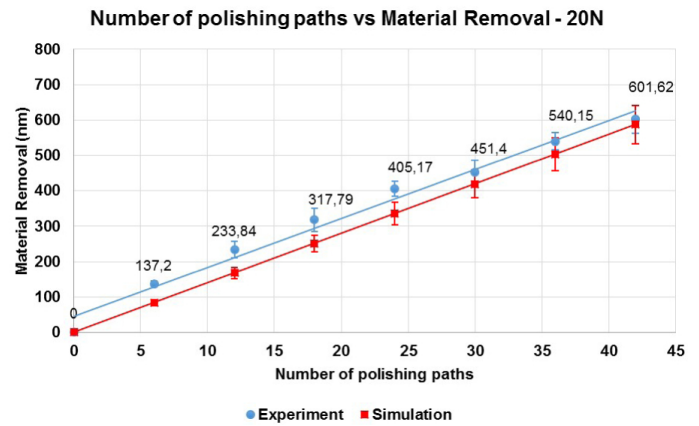

FIG. 7 Material removal correlation between experiment and simulation results for an applied pressure of 20 N.

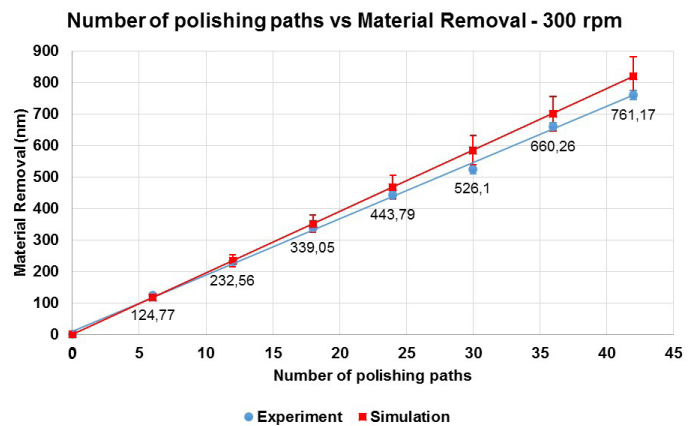

FIG. 8 Material removal correlation between experiment and simulation results for an applied rotation speed of 300 rotations per minute.

### 5.3 Correlation between experiment and simulation

With the results obtained from experiments and simulation, a correlation is possible. Using a factor and the simulation values it is possible to predict the material removal while varying the pressure and the rotation speed of the tool. As already stated above pressure was varied in the following values: 10 N, 20 N, 30 N, 40 N and the rotation speed was varied in 100 rpm, 200 rpm, 300 rpm and 400 rpm. In Figure 7 and Figure 8 are some representative results for a pressure of 20 N and a rotation speed of 300 rpm.

## 6 CONCLUSIONS

This research work led to a development of a simulation model. This model uses the finite element method and was created with the program LS-Dyna. The simulation model results could be correlated with the actual removal of material on plastic samples. Despite a 10% deviation, the results from the FEM simulation showed a good correlation with the experimental data. This deviation is probably caused by the different processing of the simulation compared to the experiment. The simulation uses a friction principle and the deformation in the Z-direction is taken into consideration. The experiment uses a polishing slurry with small grains, which

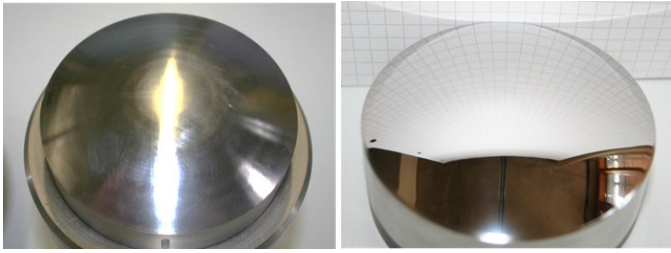

FIG. 9 Convex Steel Mould before (left) and after (right) polishing.

are in contact with the surface and these are responsible for the actual removal of material. The prediction of material removal, using this simulation model, is possible for the variation of two polishing parameters, the pressure and the rotation speed of the polishing tool. Future experiments will be conducted for harder materials like hardened steel (Figure 9) [7]. This will be a radical change because of the properties and hardness of the material, resulting in much smaller material removal rates over time. The FEM model which actually uses the elastic-plastic materials behaviour will be extended in future work to the microscopic removal of flakes or chips during the polishing process.

## 7 ACKNOWLEDGEMENTS

The authors would like to thank the German Federal Ministry of Education and Research for supporting the research project Ingenieurwachstums VREIFORM.

## References

- [1] S. Hwa, and R. Miller, *Chemical Mechanical Polishing in Silicon Processing* (Academic Press, San Diego, 1999).
- [2] J. Bliedtner, G. Gräfe, and R. Hector, *Optical Technology* (McGraw-Hill, New York, 2011).
- [3] E. Brinksmeier, O. Riemer, and A. Gessenharter, "Finishing of structured surfaces by abrasive polishing," *Precis. Eng.* **30**, 325-336 (2006).
- [4] R. Boerret, A. Kelm, H. Thiess, and V. Giggel, "ASPHERO5 - simulation and analysis of the aspherical polishing process," *Key Eng. Mat.* **364**, 488-492 (2008).
- [5] M. Speich, W. Rimkus, R. Börret, and D. K. Harrison, "Materialabtrag beim Polieren - Finite Elemente Simulation und Versuch," in *Proceedings to 11th LS-Dyna Forum* (DYNAmore, Ulm, 2012).
- [6] F. W. Preston, "The Theory and Design of Plate Glass Polishing Machines," *Journal of the society of glass technology* (1927).
- [7] R. Boerret, J. Raab, and M. Speich, "Mould production for polymer optics," *Proc. SPIE* **9192**, 91921L (2014).